



Type : BM 23C

200 WATT, 220/240VAC, 25.000 r.p.m.

For the ultimate performance in all applications including jewellery, moulding and dental laboratory. BM23C offers high torque at all speeds and smooth, controlled acceleration up to 25.000 r.p.m.

Flexible Shaft Machine

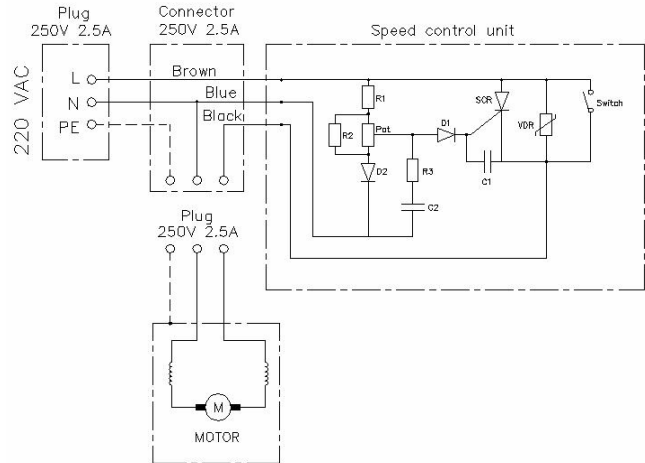
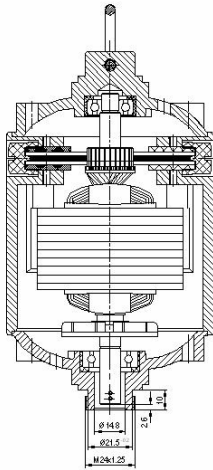

MOTOR TYPE	MOTOR CODE	TEST VOLT. (V)	TEST FREQ. (Hz)	MOTOR PERFORMANCE VALUES													
				At No Load		At Stall		At Maximum Efficiency				At Maximum Power					
				Speed (RPM)	Cur. (Amp)	Torque (Ncm)	Cur. (Amp)	Torque (Ncm)	Speed (RPM)	Cur. (Amp)	Eff. (%)	Pout (W)	Torque (Ncm)	Speed (RPM)	Cur. (Amp)	Eff. (%)	Pout (W)
BM23C	923.53.011	220	50	17927	0.473	43.59	2.078	13.4	8547	1.071	56.07	119.97	26.5	5118	1.625	46.28	142.05

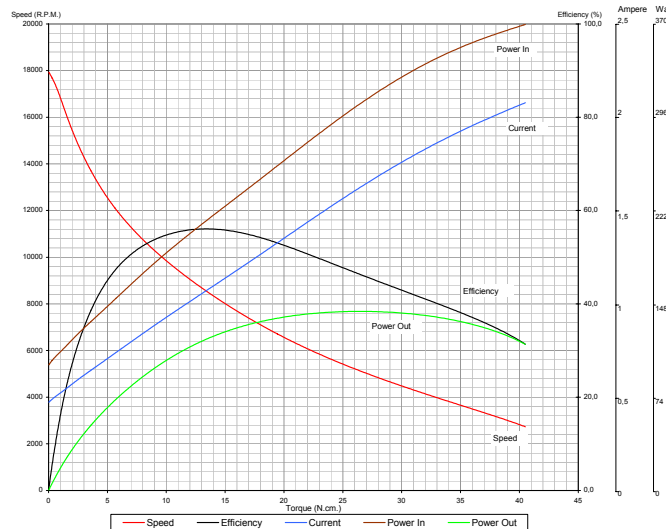

Remarks:

- Documents here includes only reference values. BALKAN MOTOR A.Ş. has the right to revise them without any prior information.
- BALKAN MOTOR A.Ş. could modify all its products according to customer requirements.

BALKAN MOTOR SANAYİ VE TİCARET A.Ş.

Yenibosna Sanayi Caddesi No:21 34530 Bahçelievler/Istanbul/TURKEY

Tel:+90 (212)551 01 00 (7 Lines) Fax: +90 (212) 551 31 67 www.balkanmotor.com.tr e-mail: balkan@balkanmotor.com.tr.

